

- ▶ worksheet: positron.hep.upenn.edu/p8/files/ws25.pdf
- ▶ hands-on exercise (!) + 3 problems + 1 XC.
- ▶ For Friday, read my prepended notes then **quickly skim** O/K ch8 (beams part II), which tells you how $V(x)$ and $M(x)$ relate to forces and torques and stresses and strains within the beam. Then for Monday there will be a video on the same topic (but more focused).
- ▶ 30/33 of you have signed up for exam times on my google-doc signup sheet. Please sign up, and try to form groups of 2 or 3.
- ▶ We'll do exam problems in random order, and we'll almost certainly run out of time before we run out of problems. I decided to include about $2\times$ as many problems as will fit in 2 hours, but my solutions for some or nearly identical problems are online at positron.hep.upenn.edu/p8/files/oldexams.
- ▶ I have to draw a couple of figures, then I should be able to put the exam problems online tomorrow.

Physics 8, Fall 2021, Worksheet #25.

Upload PDF (smartphone scan or tablet edit) to Canvas at or shortly after end of class on Wed, Dec 1, 2021.

Problems marked with () must include your own drawing or graph representing the problem and at least one complete sentence describing your reasoning.*

Discuss each problem with your teammates (usually groups of 3), then write up your own solution. Be sure to compare final results with your teammates, as a way to catch mistakes. It can also be very interesting when you and a teammate use different methods to arrive at a result! Do not hesitate to ask for help from other students, from Melina, or from Bill.

1. Hands-on activity! Materials: 1.3 meter ringstand with protruding screwdriver for pivot. Wooden meter stick with holes drilled at 25 cm intervals. Ordinary wooden meter stick. Plastic meter stick. Wooden two-meter stick. Set of masses up to 1 kg. Tabletop vise. Several binder clips.

As you go along, quickly jot down just enough to convince Melina that you tried and understood most parts of the exercise. But the main goal is to have fun engaging hands-on with the physics. Feel free to go off-piste a bit and be creative! (If you do, briefly describe what you did, or call Bill or Melina over to see.)

(a) Using the ringstand to pivot the meter stick about its 50 cm hole, position one binder clip at each end of the meter stick such that you can get two 200 g masses to balance, one suspended from each end. (This establishes your setup.)

(b) Pick several other combinations of masses (eg 200 g and 500 g, or 500 g and 1 kg) and when you get them to balance, verify that the positions where they balance are consistent with your understanding of torque. Jot down what masses you used and where they balanced.

(c) Try using the hole at 25 cm to convince yourself that the mass of the wooden meter stick is approximately 150 grams. Jot down an EFBD for the scenario you set up, illustrating why this works (eg where the line of action is for the gravitational force exerted by Earth on the meter stick). You can make 150 g by daisy-chaining 100 g and 50 g, or you can find your own cleverer solution.

(d) Try gently flexing the plastic meter stick and the ordinary wooden meter stick, to assess their stiffness. Since the two cross-sections are similar (though not identical, unfortunately), which material seems to have the larger Young's modulus? Try this comparison in both the "on the flat" (like a plank) and the "on edge" (like a joist) orientations. Which orientation has the larger "second moment of area" (aka "area moment of inertia")? In which orientation is the "beam" stiffer? A useful result that you will not see until O/K ch8 and the corresponding upcoming video is that the radius of curvature R (which is infinity for a straight line and gets smaller as the beam becomes more tightly curved) is given by $R = EI/M$ where E is Young's modulus, $I = \int y^2 dA$ is the second moment of area, and M is the "bending moment," ie the internal torque within each section cut through the beam — which is proportional to the torque that you are applying with your two hands to the beam.

(e) Set up a cantilever using a wooden meter stick, either on end or on the flat. Your fellow student and the tabletop vise may both be helpful for holding the fixed end onto the table. Use a binder clip to attach a single concentrated load to the end of your cantilever, and watch the beam deflect under load. (Start with 200 g and go up if appropriate.) We'll see in O/K ch8 and the corresponding video that when you put a concentrated load P (for "point-like" force, as engineers write) at the far end of a cantilever of length L , the vertical deflection of the far end of the beam is $PL^3/(3EI)$, where E is Young's modulus and I is second moment of area.

(f) Try a couple of values of the load P to verify (roughly) that the deflection is proportional to the mass you place at the end.

(g) For a given load, try the same meter stick both “on edge” and “on the flat” to see the effect of the I factor. The aspect ratio of these wooden meter sticks’ cross-section is about 3.2, whose square is approximately 10. Thus I is about $10\times$ larger “on edge” vs “on the flat.” Thus, the deflection, for a given load, should be about $10\times$ as large “on the flat” as it is “on edge.” Try this! You can do it side-by-side if you use two wooden meter sticks of the same cross-section and keep the lengths the same.

(h) Compare the wooden meter stick side-by-side with the plastic meter stick (cross-sections are similar, but unfortunately not identical), to see the effect of the E factor, Young’s modulus.

(i) Use the long two-meter stick at a couple of different lengths (eg 0.5 m vs 1.0 m overhang) to see the effect of the L^3 factor. If you double the length of a cantilever with a point-load at its end, you multiply the deflection $\times 8$.

(j) Though we are mostly skipping the topic of vibration this semester, one important result we may have time to see very briefly is that for many systems, the natural frequency of oscillation is proportional to $\sqrt{(\text{stiffness})/(\text{inertia})}$. The stiffness of the wooden meter stick “on edge” is about $10\times$ as large as “on the flat,” but the inertia of the two configurations is identical. Try plucking a wooden cantilever in each of the two configurations and see if you can hear that the natural frequency (or pitch) “on edge” is about $3\times$ as high as the natural frequency “on the flat.” (When you increase pitch $\times 3$, you go up to the next octave, then go up another fifth, since an octave is $\times 2$ and a fifth is $\times 1.5$)

(k) As you increase the length of the cantilever the stiffness decreases much faster than the inertia increases, so the natural frequency goes down as you make your cantilever longer. Try this! (By the way, the end of a uniformly-loaded cantilever (eg under its own weight), has deflection $wL^4/(48EI)$, ie proportional to L^4 .)

2. (longer — counts double) (a) A simply-supported beam of length $L = 6.00$ m carries a uniform distributed load $w = 4.00$ kN/m along its entire length. Solve for the three “reaction” forces exerted by the supports: the upward force R_{Ay} exerted by the support at A , the horizontal force R_{Ax} exerted by the support at A , and the upward force R_{By} exerted by the support at B .

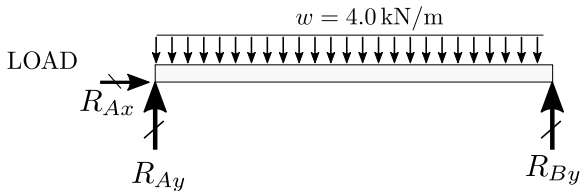
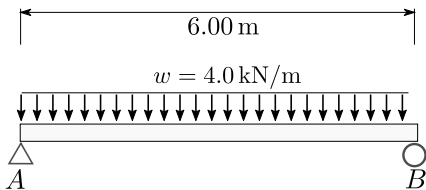

(b) A simply-supported beam of length $L = 6.00$ m carries a single concentrated load 9.00 kN at mid-span. Solve for the three “reaction” forces exerted by the supports: the upward force R_{Ay} exerted by the support at A , the horizontal force R_{Ax} exerted by the support at A , and the upward force R_{By} exerted by the support at B .

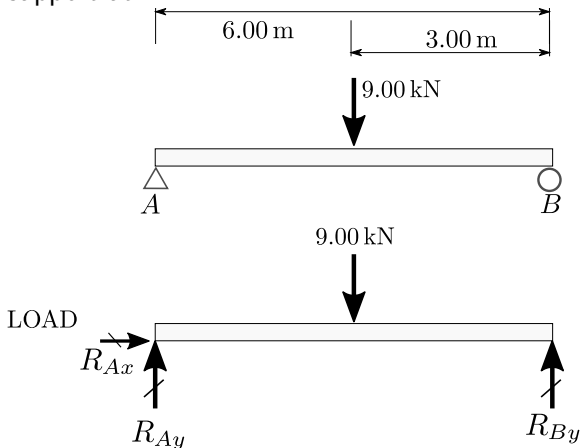

(c) A cantilever beam of length $L = 6.00$ m carries a uniform distributed load $w = 4.00$ kN/m along its entire length. Solve for the upward “reaction” force R_y exerted by the wall on the right end of the beam. Also solve for the moment (torque) M exerted by the wall on the beam: to do this, use the right end of the beam (at the wall) as a pivot, and let M be whatever torque is needed to make all torques (moments) add up to zero for equilibrium.

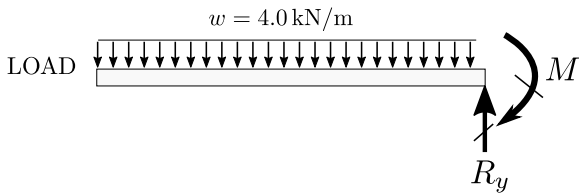
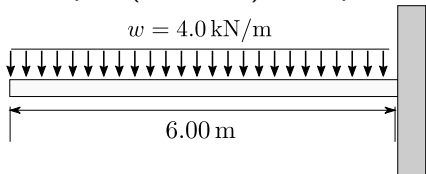

(d) A cantilever beam of length $L = 6.00$ m carries a single concentrated load of $w = 9.00$ kN at its left end. Solve for the upward “reaction” force R_y exerted by the wall on the right end of the beam. Also solve for the moment (torque) M exerted by the wall on the beam: to do this, use the right end of the beam (at the wall) as a pivot, and let M be whatever torque is needed to make all torques (moments) add up to zero for equilibrium.

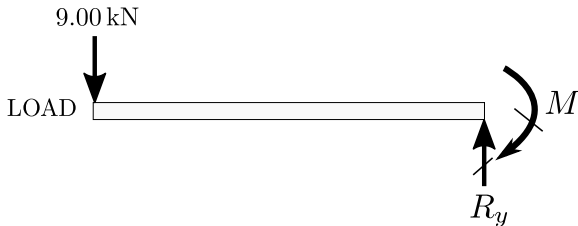
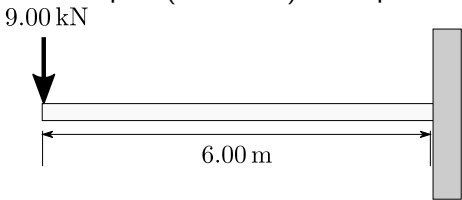

(e) For each of the following four shear/moment diagram pairs, write in the letter **A**, **B**, **C**, or **D** to indicate whether the graphs correspond to the beam shown in part (a), part (b), part (c), or part (d) of this problem (above). **For full credit, please include some reasoning for your selections.**

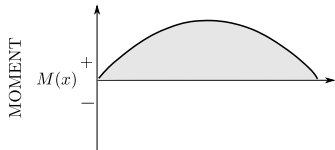
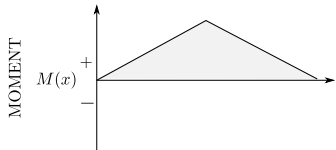
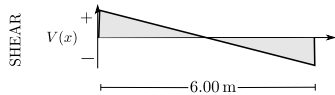
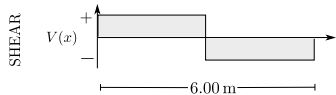
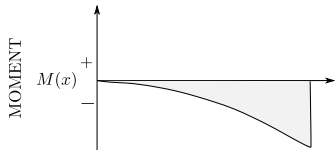
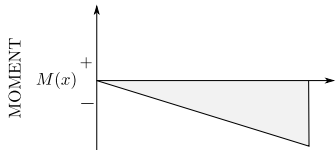
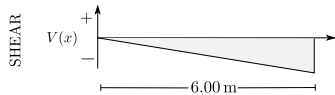
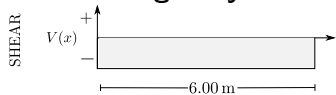

3. A simply supported beam (i.e. supported with a pin beneath one end and a roller beneath the other end) is 4.0 m long and carries two vertical (downward) point loads: 1.5 kN at distance 1.0 m from the left support and 2.5 kN at distance 2.0 m from the left support. (a) Draw the load diagram for the beam, including all vertical forces acting on the beam—both the load and the vertical support (“reaction”) forces. (b) Beneath the load diagram, draw the shear diagram $V(x)$ for the beam. (c) Beneath the shear diagram, draw the bending-moment diagram $M(x)$ for the beam. (d) Comment on whether the beam is smiling or frowning and how this relates to the sign of the bending moment.

4. A simply supported beam is 4.0 m long and carries a uniformly distributed (downward) load of 1.0 kN/m. (a) Draw the load diagram for the beam, including all vertical forces acting on the beam—both the load and the vertical support (“reaction”) forces. (b) Beneath the load diagram, draw the shear diagram $V(x)$ for the beam. (c) Beneath the shear diagram, draw the bending-moment diagram $M(x)$ for the beam. (d) What is the meaning of the $V(x)$ and $M(x)$ curves? For instance, if you were to section the beam a distance x from the left side, what would $V(x)$ and $M(x)$ tell you about the interactions (forces and torques) between the left and right sides of the section?

XC5*. (If you work this one out, I think even Prof Farley will be impressed! It is also a fun (I think) application of what I might call “graphical calculus.” And see the end of this problem for a hint on what your graphs might look like. Also consider the online calculator at www.bendingmomentdiagram.com.) For the overhang beam shown below.

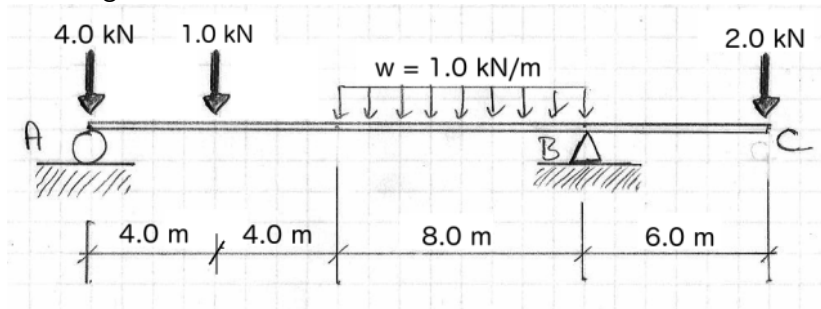

(a) Find the support forces A_y , B_x , and B_y exerted on the beam by supports A and B.

(b) Draw load (EFBD), shear (V), and bending moment (M) diagrams for the beam.

(c) What are the largest magnitude of the shear V (in kilonewtons) and the largest magnitude of the bending moment M (in kilonewton-meters)?

